



E I C H H O L T Z

111827 CHANDELIER LARGO

ASSEMBLY INSTRUCTION

- 1** Determine the desired height of your chandelier and connect the extension pipes.

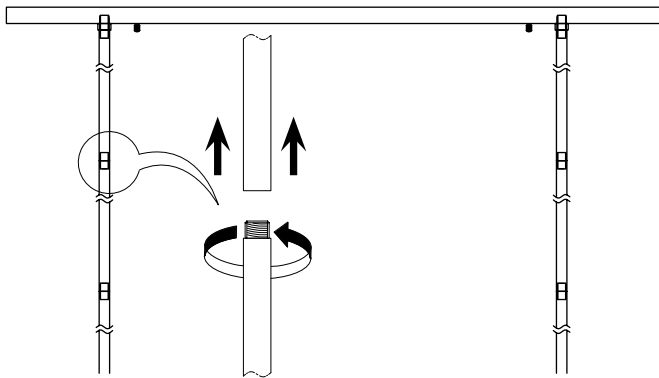

- 4** Connect the 3 power wires according to their colours to the transformer. Brown is the live wire, blue is the neutral wire, green/yellow is the earth wire. Place the ceiling canopy (B) flush against the ceiling and fix it securely with the two nuts supplied.

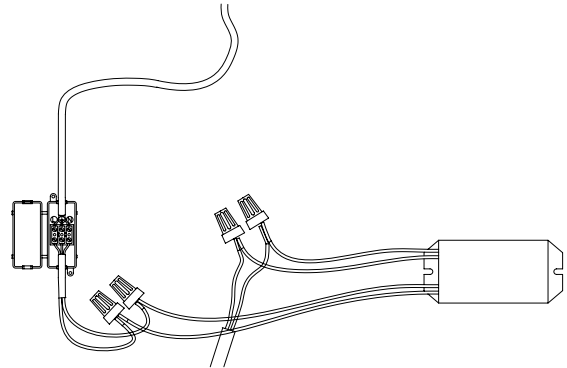

- 2** Thread the wire from the lamp through the pipe.

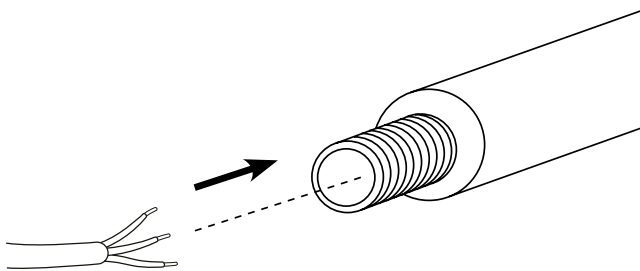

- 5** Adjust the arms until your luminaire is balanced. Place the G4 lightbulbs (included) and carefully screw on the glass balls.

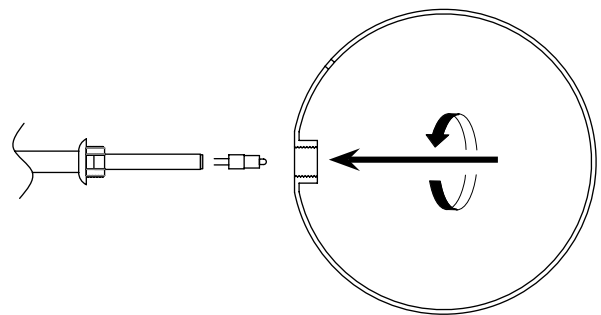

- 3** Fix the ceiling plate (A) to the ceiling by using mounting plugs and screws suitable to your ceiling type. Guide the wires through the plate. Place or hold the lamp in an elevated position in such a way that the wires can freely reach the ceiling junction box.

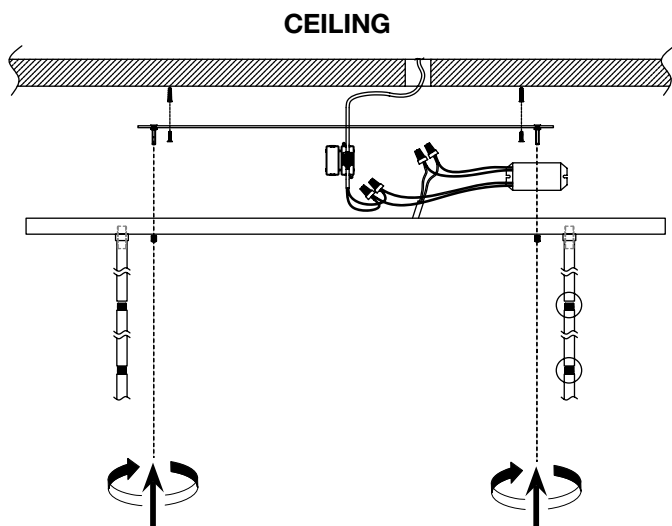

FINAL

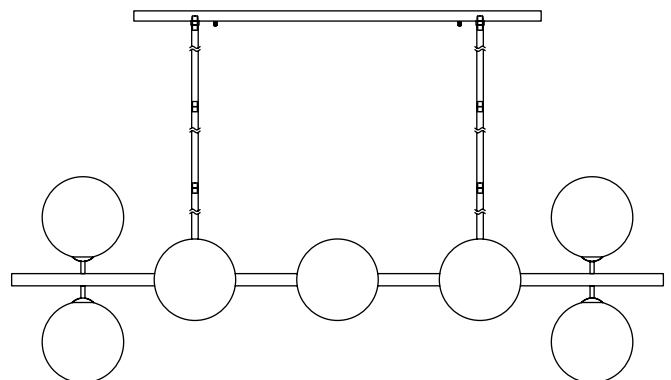

Turn-off the electricity supply at main circuit panel before installing. Do not connect electricity supply until your ceiling light is fully assembled and installed.

CARE INSTRUCTION

Wipe clean with soft, dry cloth. Always avoid the use of harsh chemicals or abrasive cleaners as they may cause damage to the fixture's finish.